

INSTALL FLUSH TO TOP SURFACE

TORQUE TO 75 Nm

INSTALL WITH LIPS TOWARDS ROD END

INSTALL WITH LIPS TOWARDS TOP OF BLOCK

TORQUE TO 3 Nm

THREAD IN GENTLY TO BOTTOM, THEN BACK OUT 1/2 TURN

TORQUE TO 3 Nm AFTER SETTING TIME DELAY

TORQUE TO 3 Nm

TORQUE TO 10 Nm

1 2

NO	QTY	PART NO	DESCRIPTION	STD SEAL KIT	FILTER KIT	SPRING KIT
1	2	21440023	SHSS, HOLLOW			
2	2	21500046	SCREW, CAP, BTNH, M5-0.8 X 6, ALY			
3	1	21540000	SHSS, FLAT/CUP, METRIC			
4	1	23350114	SPRING, COMPRESSION			X
5	1	30601144	PLUG, SOCH, SAE 4			
6	2	31050009	FILTER, DISC, SAE 4, 25 MICRON		X	
7	4	31050012	DIFFUSER, DISK, SAE 4		X	
8	1	31091004	FILTER, BRONZE, SINTERED, .313, GR 46			
9	2	39000050	O-RING, (-204)	X		
10	1	39000077	O-RING, (-009)	X		
11	1	39010011	SEAL, BEVEL, 3/16 X 3/32 X 3/8	X		
12	4	39010061	BU RING, (-010)		X	
13	1	39011027	SEAL, BEVEL, 1-1/16 X 3/32 X 1-1/4	X		
14	1	39011097	BU RING, (-121)	X		
15	1	39054009	BU RING, (-106)	X		
16	2	39055013	SEAL, BONDED, M5	X		
17	2	43068006	PLUG, PORT, HOLLOW HEX, G1/4			
18	1	70343760	VALVE, CHECK, SAE 4, 30 PSI			
19	1	87043001	PISTON, VALVE, UNCLAMP DELAY			
20	1	87043002	CAP, SPRING, VALVE, UNCLAMP DELAY			
21	1	97020002	ASSY, NEEDLE & STEM, FC, UDV			
N/A	N/A	60-7043-00	KIT, SEAL, VALVE, UNCLAMP DELAY	NOTED	N/A	N/A
N/A	N/A	60-7043-01	KIT, FILTER, VALVE, UNCLAMP DELAY	N/A	NOTED	N/A
N/A	N/A	61-7043-01	KIT, SPRING, VALVE, UNCLAMP DELAY, 7MPa	N/A	N/A	NOTED

NOTE:  
 1) APPLY LUBRICANT TO ALL SEALS PRIOR TO INSTALLATION  
 2) TOOL P/N 65-6000-00 IS REQUIRED FOR INSTALLATION OF CHECK VALVE CARTRIDGE

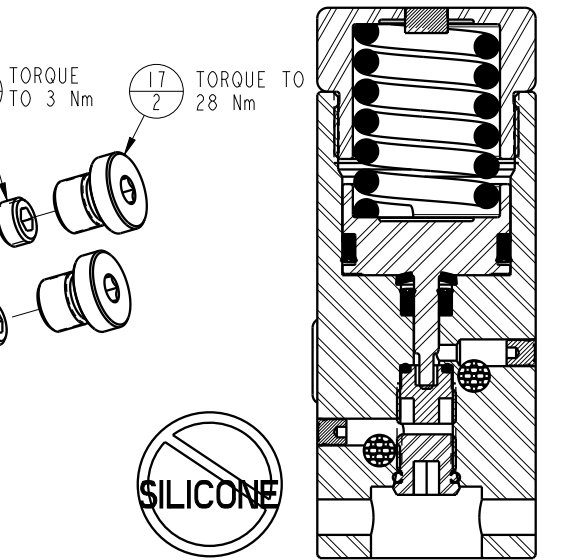

PARTS LIST		
	VEKTEK, INC. 1334 E. SIXTH AVE. P.O. BOX 625 EMPORIA, KS. 66801 U.S.A.	
ASSEMBLIES AFFECTED	PARTS LIST, ASSY, VALVE, UNCLAMP DELAY, 7MPa	
L7-0431-00	*****	
SIZE A	LPL7029	REV A

A	2829	RELEASE	ALUTHI	3-31-15
REV	IN ACCORDANCE WITH ECN	EFFECTIVE DATE	REVISED BY	DATE
DRW BY:	ALUTHI	DRAWING STATUS: <b>Released</b>		
DATE:	3-24-15	PRODUCTION APPROVED FOR RELEASED STATUS ONLY		

<b>Vektek LLC</b> 1334 East Sixth Ave. P.O. Box 625 Emporia, Ks. 66801 U.S.A.	<b>Instruction Sheet</b>	<b>IS7005</b>		
		<b>REV: B</b>	<b>ECN: 3268</b>	
		<b>REV. BY/DATE: JDW</b>	<b>05/14/18</b>	
		<b>APPR/DATE: TDK</b>	<b>05/17/18</b>	
<b>TITLE: Unclamp Delay Valve Application Setup Guide</b>				

Application Setup Guide

# Unclamp Delay Valve

P/N's: 70-4310-00, 47-0431-00 & L7-0431-00



U.S. PATENT No. 9,683,669



<b>Vektek LLC</b> <b>1334 East Sixth Ave.</b> <b>P.O. Box 625</b> <b>Emporia, Ks. 66801</b> <b>U.S.A.</b>	<b>Instruction Sheet</b>	<b>IS7005</b>			
		<b>REV: B</b>	<b>ECN: 3268</b>		
		<b>REV. BY/DATE: JDW</b>	<b>05/14/18</b>		
		<b>APPR/DATE: TDK</b>	<b>05/17/18</b>		
<b>TITLE: Unclamp Delay Valve Application Setup Guide</b>					

## Table of Contents

Introduction to the Unclamp Delay Valve.....	3
Operation .....	3
Applications.....	3
Mounting & Plumbing Options.....	6
Manifold Mounted under a Sequence Valve: .....	6
Externally Plumbed under a Sequence Valve:.....	7
Standalone Manifold Mount: .....	8
Standalone Externally Plumbed: .....	8
Bleeding.....	9
Time Delay Adjustment .....	9
Adjustment Instructions:.....	9
Q & A .....	11
Trouble Shooting .....	12

<b>Vektek LLC</b> 1334 East Sixth Ave. P.O. Box 625 Emporia, Ks. 66801 U.S.A.	<b>Instruction Sheet</b>	<b>IS7005</b>			
		<b>REV: B</b>	<b>ECN: 3268</b>		
		<b>REV. BY/DATE: JDW</b>	<b>05/14/18</b>		
		<b>APPR/DATE: TDK</b>	<b>05/17/18</b>		
<b>TITLE: Unclamp Delay Valve Application Setup Guide</b>					

## Introduction to the Unclamp Delay Valve

The unclamp delay valve is an accessory valve that controls timing of single acting devices during unclamping. It provides a delay to control the “unclamp” in single acting devices and can be used in either single or double acting systems. The unclamp delay valve will be further known as the UDV.

## Operation

The VektorFlo® Unclamp Delay Valve operates as a normally open element in a hydraulic clamping system. See the schematic below to understand operation. During clamping, low pressure fluid flows freely through the valve to downstream devices. As pressure in the system builds, the mechanical pilot piston moves away from the check valve allowing it to close, once full system pressure is reached and flow in the system stops. If pressure leaks off in downstream devices, the check valve will re-open and replenish pressure. During unclamping, the inlet pressure falls with main system pressure but downstream pressure is held constant by the check valve. When inlet pressure falls to a low level, spring force starts to move the mechanical pilot piston towards the check valve at a rate set by the flow control and oil viscosity. The mechanical pilot piston then moves through its stroke and encounters the check valve. Spring force opens the check valve to release all downstream pressure to the power unit reservoir.

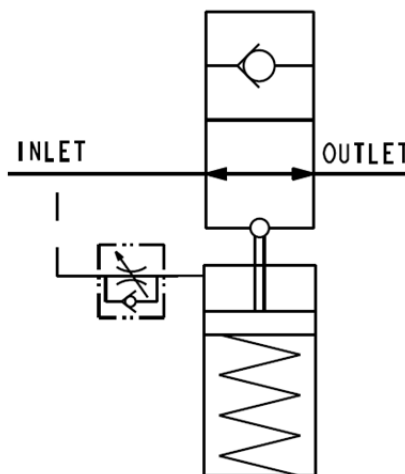

The unclamp delay valve is unlike any pilot operated check valves because it doesn't require a 3<sup>rd</sup> pilot line to open the valve. It is a completely self-contained mechanical device that does not need outside input.

## Applications

As mentioned in the introduction, the unclamp delay valve controls the unclamp timing of single acting devices. The UDV is a first of its kind device that provides this functionality. It could be used to hold a primary clamp over a fixed locator while other clamps unclamp or it could be used to delay the unclamp of work supports to eliminate work piece movement.

<b>Vektek LLC</b> <b>1334 East Sixth Ave.</b> <b>P.O. Box 625</b> <b>Emporia, Ks. 66801</b> <b>U.S.A.</b>	<b>Instruction Sheet</b>	<b>IS7005</b>			
		<b>REV: B</b>	<b>ECN: 3268</b>		
		<b>REV. BY/DATE: JDW</b>	<b>05/14/18</b>		
		<b>APPR/DATE: TDK</b>	<b>05/17/18</b>		
<b>TITLE: Unclamp Delay Valve Application Setup Guide</b>					

The unclamp delay valve is not commonly needed in every hydraulic fixture application. However, there are applications where the UDV can help solve problems in new or existing fixtures. If your fixture has problems with back pressure the UDV can help.

In the past, customers have tried to solve back pressure work piece movement issues by using a flow control in the reverse direction. Not only will a flow control installed in the reverse direction not work but it will more than likely make the problem worse. In the application of a work support, a flow control installed in the reverse direction will cause the work support plunger to return extremely slow. The reason a flow control installed in the reverse direction will not work is that it controls flow only, not pressure. Oil has to be moving for the effect of a flow control to be seen. Rapid depressurization of oil creates almost no oil flow. Pressure levels can actually rise and fall through a flow control if the flow is small enough. Let's discuss the example of using a flow control in the reverse direction to delay the unclamping of work supports as mentioned in the first applications paragraph. Assuming the work support is fluid advanced, a flow control is installed to limit the flow of oil during unclamping. During unclamping, as pressure falls from system operation level to 0, the sleeve is the first to release. The oil volume change is negligible so there is virtually no flow. Adding the flow control shows no measureable result in delaying the sleeve unclamp. In an attempt for the flow control to have an effect during the release of the small oil volume around the sleeve, the flow control is adjusted so it is nearly closed. This creates a real problem when it's time for the plunger to return. The oil volume contained in the piston bore is typically 10 times that around the sleeve. The flow control limits the speed of the fluid advance piston movement and because the flow control was adjusted to nearly closed it may take minutes for the work support plunger to return to the retracted position. Not acceptable for most applications. The unclamp delay valve works because it holds the sleeve locked, then opens and allows full flow of both the sleeve and piston oil.

If back pressure is causing work piece movement or work support failure when unclamping over the top of a work support, the UDV is what you need. Typically work piece movement that leads to work support failure is caused by the clamp over the top of the work support. More often than not, these clamps are single acting. The movement is caused by back pressure inside the single acting clamp. When the valve is shifted to unclamp, the work support quickly depressurizes due to its small internal oil volume. The clamp over the top typically has substantially more oil volume and takes longer to depressurize and start moving and release clamping force from the work piece. Work support failure is caused by the sleeve releasing while the clamp overtop is still clamping with nearly full clamping force. This usually happens so rapidly that it is difficult to see with the naked eye. The use of a dial indicator on the part and videoing the unclamp can be very helpful in diagnosing these applications by playing back frame by frame to see the actual movement. The fix is installing the UDV in the work support circuit to delay the unclamp of the work support. The UDV keeps the work support locked for a short 5 second delay while the clamp overtop has time to depressurize and lift off the work piece. The work support is then able to depressurize without a load against the plunger as the sleeve releases.

As mentioned earlier, not every fixture has back pressure problems or needs the unclamp delay valve. However, there are several common themes found in the fixture designs where the unclamp delay valve is needed. It typically has to do with the work piece shape and location of hard stops on the fixture. If the hard stops are positioned so that the work piece cannot move during unclamping the UDV is probably not needed.

<b>Vektek LLC</b> 1334 East Sixth Ave. P.O. Box 625 Emporia, Ks. 66801 U.S.A.	<b>Instruction Sheet</b>	<b>IS7005</b>		
		<b>REV: B</b>	<b>ECN: 3268</b>	
		<b>REV. BY/DATE: JDW</b>	<b>05/14/18</b>	
		<b>APPR/DATE: TDK</b>	<b>05/17/18</b>	
<b>TITLE: Unclamp Delay Valve Application Setup Guide</b>				

Especially, if the work supports are inside of the triangle created by the hard stops, movement is not possible that can lead to work support failure. See example sketch below.

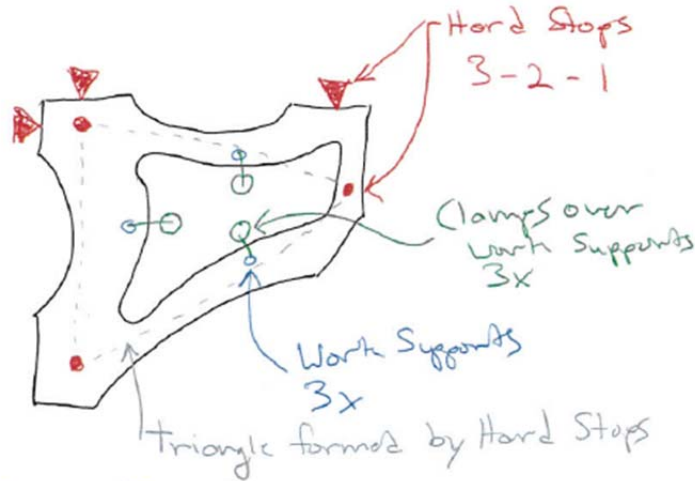

However, if the work piece shape is such that it cantilevers or overhangs the hard stops, it is possible that movement can take place. When the work piece geometry requires work supports outside the triangle formed by the hard stops, clamps over top of the work supports can rock or move the part during unclamping. See example sketch below.

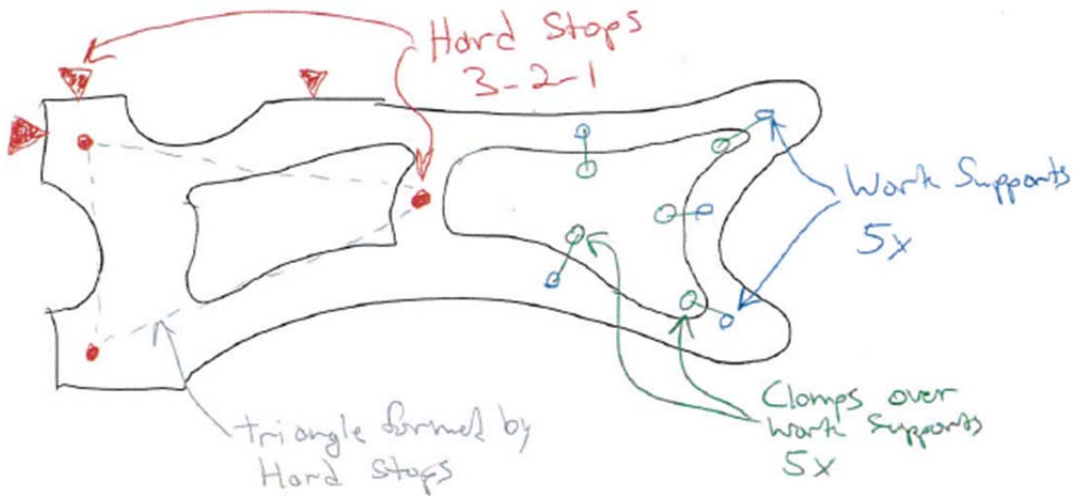

Commonly, in the single acting systems where work supports are located outside of the triangle formed by the hard stops, the primary clamps over the hard stops unclamp first because there is no sequence valve for their return oil to go through. They are the first clamps to move during unclamping because there is no plumbing restrictions and they rapidly depressurize. This allows the part to rock and lift off the hard stops.

<b>Vektek LLC</b> 1334 East Sixth Ave. P.O. Box 625 Emporia, Ks. 66801 U.S.A.	<b>Instruction Sheet</b>	<b>IS7005</b>			
		<b>REV: B</b>	<b>ECN: 3268</b>		
		<b>REV. BY/DATE: JDW</b>	<b>05/14/18</b>		
		<b>APPR/DATE: TDK</b>	<b>05/17/18</b>		
<b>TITLE: Unclamp Delay Valve Application Setup Guide</b>					

## Mounting & Plumbing Options

The unclamp delay valve has many mounting and plumbing options. It was designed to manifold mount underneath a Vektek sequence valve because most applications require sequencing during clamping. It also can be manifold mounted as a standalone valve or even externally plumbed.

### Manifold Mounted under a Sequence Valve:

Let's start with the most common application, a new or existing fixture, where the UDV will be manifold mounted underneath a sequence valve. Use 2X 1/4-20 X 3-1/4" socket head cap screw or M6-1 X 80mm socket head cap screw to mount both the sequence valve and unclamp delay valve. 1) Prep the sequence valve by removing the plugs from the manifold ports and install the manifold mount o-rings. 2) Prep the UDV by removing the inlet manifold port plug. 3) Finish prepping the UDV by removing the outlet manifold port plug and installing the manifold mount o-rings. Finally, insert the bolts through the sequence valve and UDV and bolt to fixture.

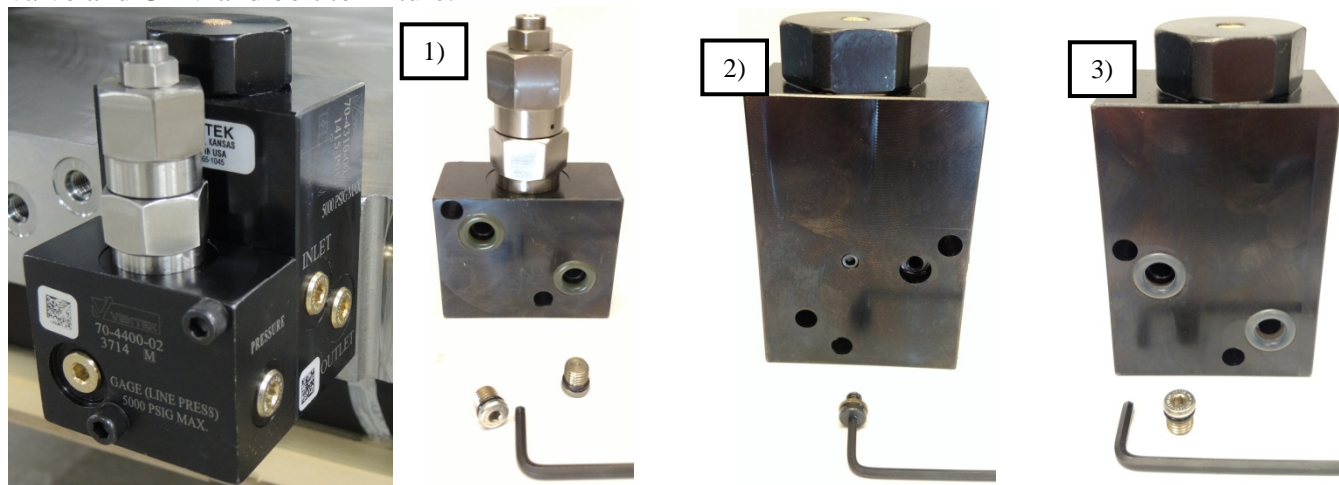

<b>Vekttek LLC</b> 1334 East Sixth Ave. P.O. Box 625 Emporia, Ks. 66801 U.S.A.	<b>Instruction Sheet</b>	<b>IS7005</b>			
		<b>REV:</b>	<b>B</b>	<b>ECN:</b>	<b>3268</b>
		<b>REV. BY/DATE:</b>	<b>JDW</b>	<b>05/14/18</b>	
		<b>APPR/DATE:</b>	<b>TDK</b>	<b>05/17/18</b>	
<b>TITLE: Unclamp Delay Valve Application Setup Guide</b>					

Externally Plumbed under a Sequence Valve:

The next most common application is a new or existing fixture, where the UDV will be mounted under a sequence valve and externally plumbed. Use 2X 1/4-20 X 3-1/4" socket head cap screw or M6-1 X 80mm socket head cap screw to mount both the sequence valve and unclamp delay valve. 1) Start by prepping the sequence valve by removing only the outlet manifold port plug and install the face seal o-ring. 2) Prep the UDV by removing the inlet manifold port plug. Next, insert the bolts through the sequence valve and UDV and bolt to fixture. Finally, remove the inlet SAE 4 plug from the sequence valve and the outlet SAE 4 plug from the UDV and install fittings and external plumbing. When externally plumbing, oil should go into the sequence valve through the "PRESSURE" port and come out of the UDV through the "OUTLET" port. The "SEQUENCE" port and UDV "INLET" port should remain plugged. The external plumbing should look similar to the plumbing shown in the picture below.

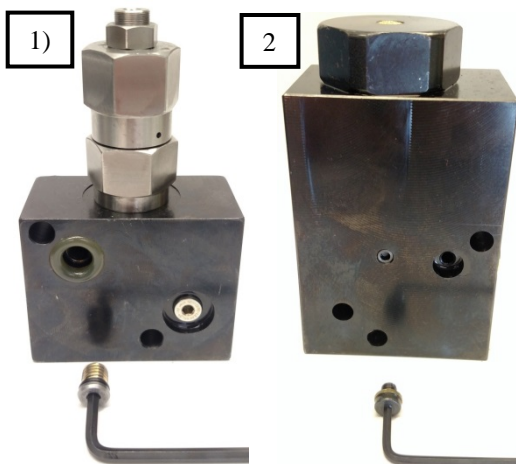
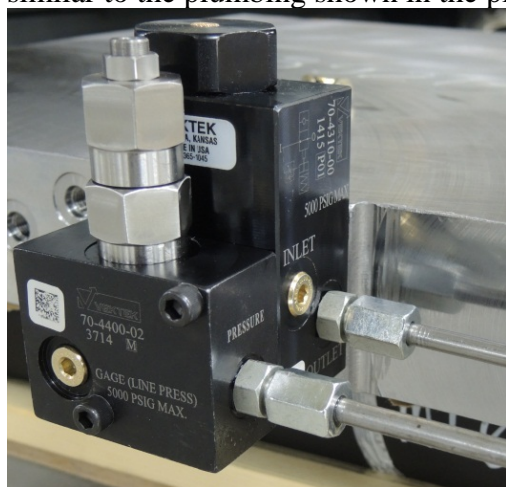

<b>Vektek LLC</b> 1334 East Sixth Ave. P.O. Box 625 Emporia, Ks. 66801 U.S.A.	<b>Instruction Sheet</b>	<b>IS7005</b>			
		<b>REV: B</b>	<b>ECN: 3268</b>		
		<b>REV. BY/DATE: JDW</b>	<b>05/14/18</b>		
		<b>APPR/DATE: TDK</b>	<b>05/17/18</b>		
<b>TITLE: Unclamp Delay Valve Application Setup Guide</b>					

Standalone Manifold Mount:

The UDV can be mounted as a standalone valve and plumbed through the manifold ports. Doing so requires the use of a crossover plate. Select the crossover plate model number from the table below needed for your UDV model.

UDV Model #	Crossover Plate Model #
70-4310-00	93-1977-00
47-0431-00	49-3197-00
L7-0431-00	L9-3197-00

Mount the UDV with crossover plate using 2X 1/4-20 X 2-1/2" socket head cap screw or M6-1 X 60mm socket head cap screw. 1) Prep the UDV by removing the inlet manifold port plug. 2) Finish prepping the UDV by removing the outlet manifold port plug and installing the manifold mount o-rings. 3) Install the manifold mount o-rings in the crossover plate. Finally, insert the bolts through the crossover plate and UDV and bolt to fixture.

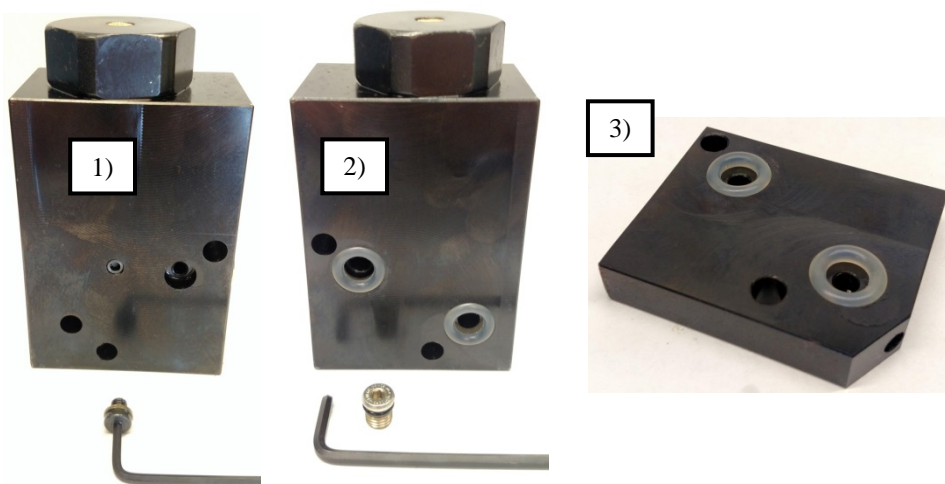

Standalone Externally Plumbed:



Mounting the valve as a stand alone and plumbing externally is the simplest way to mount and plumb the valve. Simply mount the valve using 2X 1/4-20 X 2" socket head cap screw or M6-1 X 50mm socket head cap screw, remove the INLET and OUTLET port plugs, install fittings and external plumbing. No need to remove any manifold plugs or install any manifold o-rings.

<b>Vektek LLC</b> 1334 East Sixth Ave. P.O. Box 625 Emporia, Ks. 66801 U.S.A.	<b>Instruction Sheet</b>	<b>IS7005</b>			
		<b>REV: B</b>	<b>ECN: 3268</b>		
		<b>REV. BY/DATE: JDW</b>	<b>05/14/18</b>		
		<b>APPR/DATE: TDK</b>	<b>05/17/18</b>		
<b>TITLE: Unclamp Delay Valve Application Setup Guide</b>					

## Bleeding

Bleeding the air out of hydraulic systems is important. For proper function of the unclamp delay valve it is crucial. Bleed all the air at the “OUTLET” port of the UDV and bleed at the clamping device downstream. Air left in the circuit can cause the UDV to operate sporadically. Air left in the plumbing between the UDV and downstream device may never escape or be able to return back to tank if the oil volume is small.

## Time Delay Adjustment

The time delay of the UDV is adjustable. This allows it to be tuned to any system and provide the delay needed in every application. The delay is factory preset to 5+/- 2 seconds using ISO 32 oil. Other oil viscosities may produce slightly different time delays so field adjustment may be necessary. It can be easily adjusted to a minimum of a ½ second delay to a maximum of a 10 second delay. The adjustment is made by turning the flow control screw. The graph below shows the relationship between the time delay and number of turns open.

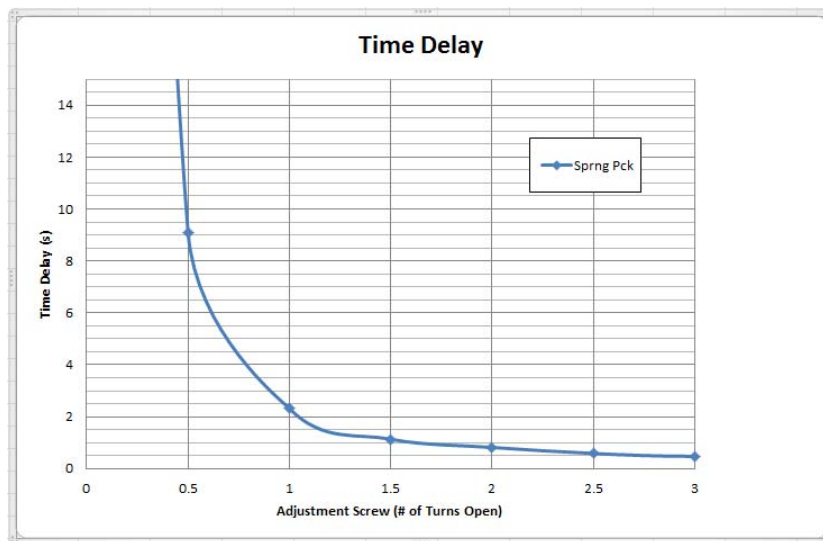

### Adjustment Instructions:

Follow the instructions below to tune your UDV to the time delay needed for your application.

- 1) Locate the time delay adjustment opposite the external ports.

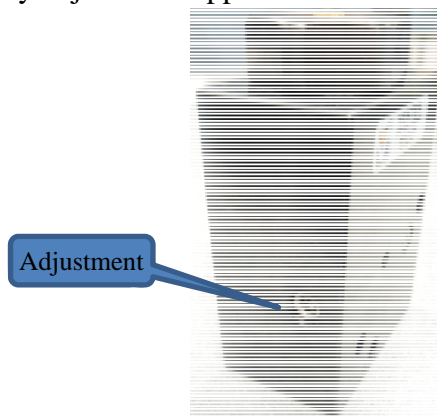

<b>Vekttek LLC</b> 1334 East Sixth Ave. P.O. Box 625 Emporia, Ks. 66801 U.S.A.	<b>Instruction Sheet</b>	<b>IS7005</b>			
		<b>REV: B</b>	<b>ECN: 3268</b>		
		<b>REV. BY/DATE: JDW</b>	<b>05/14/18</b>		
		<b>APPR/DATE: TDK</b>	<b>05/17/18</b>		
<b>TITLE: Unclamp Delay Valve Application Setup Guide</b>					

- 2) Remove the locking set screw using a 3/16" or 5mm allen wrench to access the flow control screw.



- 3) Adjust the flow control screw using a 5/32" or 4mm allen wrench.

- To make time delay longer, turn clockwise.
- To make time delay shorter, turn counter clockwise. Do not exceed 3 full turns.

Start by only turning flow control screw in 1/8 of a turn increments. Clamp and unclamp the fixture several times to determine if desired delay is achieved. Repeat step 3 as necessary to set desired delay.

If delay becomes too long or short, reset the position of the flow control by simply threading it clockwise until it gently seats in the bottom of the orifice. Then turn the screw 3/4 of a turn counter clockwise. The delay should be approximately 4-5 seconds.



- 4) Once delay is set to the desired time, install set screw to lock the delay adjustment. Use 3/16" or 5mm allen wrench and torque to 25 in-lb or 3N-m.



<b>Vektek LLC</b> 1334 East Sixth Ave. P.O. Box 625 Emporia, Ks. 66801 U.S.A.	<b>Instruction Sheet</b>	<b>IS7005</b>			
		<b>REV: B</b>	<b>ECN: 3268</b>		
		<b>REV. BY/DATE: JDW</b>	<b>05/14/18</b>		
		<b>APPR/DATE: TDK</b>	<b>05/17/18</b>		
<b>TITLE: Unclamp Delay Valve Application Setup Guide</b>					

## Q & A

**Q:** Will the unclamp delay valve work with any Vektek device?

**A:** No, Only with single acting devices. No double acting devices can be used downstream of the valve.

**Q:** Can I use the unclamp delay valve to delay more than one device downstream of the valve?

**A:** Yes, it will provide unclamp delay for multiple single acting downstream devices: swing clamps, link clamps, cylinders or work supports.

**Q:** I have a double acting system, can I use the unclamp delay valve to control the unclamp timing of a fluid advanced work support?

**A:** Yes, the unclamp delay valve can work with any single acting or spring return hydraulic devices. A fluid advance work support is a single acting, spring return device.

**Q:** I have a double acting system, can I use the unclamp delay valve to control the unclamp timing of a **double acting cylinder**?

**A:** No, the unclamp delay valve cannot be used with any double acting device downstream of the valve. If a double acting device is used downstream, there is a risk of producing a pressure spike between the UDV and double acting device. During the delay before the check valve opens in the UDV, oil on the “A” side of the double acting cylinder cannot escape. If the “B” side of the cylinder becomes pressurized, a pressure spike can occur depending on the area ratio between the “A” and “B” sides of the double acting cylinder. If timing control is desired for a double acting device, a sequence valve should be used on the “B” circuit.

**Q:** How is the unclamp delay valve different than a pilot operated check valve?

**A:** The UDV doesn't require a 3<sup>rd</sup> “B” pilot line to open. The UDV is self-sustained and only requires 2 ports: an inlet and outlet.

**Q:** If I add an unclamp delay valve to my fixture to delay the unclamp of my work supports, how will it affect my part load/unload cycle time?

**A:** In most fixtures, the time to unload a work piece will not change. The part can be unloaded as soon as the clamps are retracted. The work supports can retract after the part has been removed.

<b>Vektek LLC</b> <b>1334 East Sixth Ave.</b> <b>P.O. Box 625</b> <b>Emporia, Ks. 66801</b> <b>U.S.A.</b>	<b>Instruction Sheet</b>	<b>IS7005</b>			
		<b>REV: B</b>	<b>ECN: 3268</b>		
		<b>REV. BY/DATE: JDW</b>	<b>05/14/18</b>		
		<b>APPR/DATE: TDK</b>	<b>05/17/18</b>		
<b>TITLE: Unclamp Delay Valve Application Setup Guide</b>					

## Trouble Shooting

<b>Problem</b>	<b>Cause</b>	<b>Corrective Action</b>
The time delay is too long, I need my downstream devices to be released quicker.	The flow control is set with too much restriction.	Adjust flow control screw counter clockwise in 1/8 of a turn increments. See “Adjustment Instructions”.
The time delay is too short, I need more delay before my downstream devices release.	The flow control is set with not enough restriction.	Adjust flow control screw clockwise in 1/8 of a turn increments. See “Adjustment Instructions”.
I installed the UDV on my fixture and it worked a couple times and now it doesn’t release my downstream clamps.	There may be air in the UDV causing the check valve to not open.	Crack the outlet fitting of UDV to bleed air from inside the valve. Then crack the fitting of the downstream devices and bleed them. Cycle the fixture several times. It is very important that all air be bled from the single acting circuit. Air left in the plumbing between the UDV and downstream device may never escape or be able to return back to tank if the oil volume is small.
I’ve bled my UDV but it still doesn’t release my downstream clamp.	Back pressure in the fixture is so high the inlet port pressure never falls low enough to start the check valve opening process inside the UDV.	Crack the inlet fitting of the UDV and confirm that pressure has been released. The inlet pressure has to fall below 50 PSI for the check valve to fully open.
I’ve bled my UDV and confirmed that my inlet pressure is dropping to less than 50 PSI but the UDV will still not release my downstream devices.	The flow control setting may be out of adjustment or totally closed off. If the flow control orifice is bottomed out, the valve will never open.	See “Adjustment Instructions” and reset the position of the flow control by gently threading in to where it seats, and then back off ¾’s of a turn.